

## Features

- Top SMD internal integrated high quality external control line serial cascade constant current IC; 5V application; default on electric lights.
- Control circuit and the RGB chip in SMD 5050 components, to form a complete control of pixel, color mixing uniformity and consistency.
- The two-wire synchronous control.
- The three RGB output control, 8Bit (256) color; 5Bit (32) to adjust the brightness;
- The three constant current drive, self-detection function specific signal.
- The maximum frequency of 30MHz serial data input.
- The double data transmission, built-in support uninterrupted oscillation PWM output, can maintain a static image.

## Description

The IN-PC55TBTRGB is 5.0\*5.0\*1.6mm RGB LED with integrated IC. It is a two-wire transmission LED with three channel (RGB) intelligent driving control circuit and light emitting circuit. The LED contains a signal decoding module, data buffer, a built-in constant current circuit, and RC oscillator. It uses CMOS process, low voltage and low power consumption. It has 256 level grayscale PWM adjustment and 32 brightness adjustment. The LED uses double line transfer output, with synchronization of Data and CLK signal.

## Applications

- Full color LED string light
- LED full color module
- LED guardrail tube
- LED scene lighting
- LED point light
- LED pixel screen
- LED shaped screen

## Package Outline Dimensions & Pin Configuration

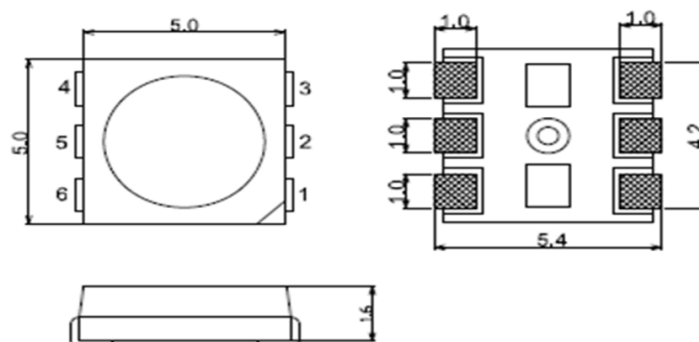

Figure 1. IN-PC55TBTRGB Package Outline Dimensions

### Pin Configuration

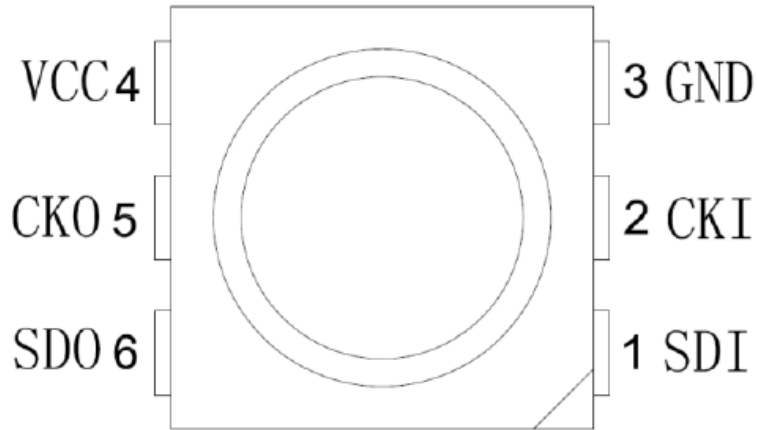

Figure 2. IN-PC55TBTRGB Pin Configuration

Notes:

1. Dimension in millimeter, tolerance is  $\pm 0.1$ mm unless otherwise noted.

Number	Symbol	Pin Name	Function Description
1	SDI	Data Input	control signal Input data
2	CKI	CLK Input	control signal Input Clock data
3	GND	Ground	The signal and power supply grounding
4	VCC	Power	power supply pin
5	CKO	CLK Output	control signal output Clock data
6	SDO	Data Input	control signal output data

### Soldering Pad Size

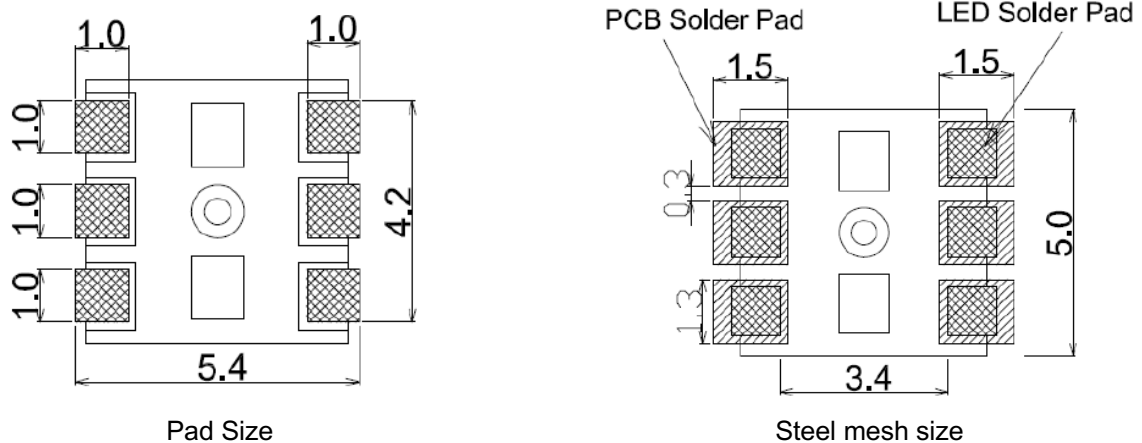

**Absolute Maximum Rating** ( $T_a = 25\text{ }^\circ\text{C}$ ,  $V_{SS}=0V$ )

Parameter	Symbol	Range	Unit
Power supply voltage	$V_{DD}$	-0.5~+5.5	V
Logic input voltage	$V_{IN}$	-0.3 ~VDD+0.3	V
Operating temperature	$T_{OPT}$	-20 ~ +80	$^\circ\text{C}$
Storage temperature	$T_{STG}$	-50 ~ +120	$^\circ\text{C}$
ESD pressure(HBM)	$V_{ESD}$	4K	V

**LED Characteristics** ( $T_A = 25^\circ\text{C}$ )

Color	20mA	
	Wavelength(nm)	Light Intensity(mcd)
Red	620-630	400-700
Green	515-530	1000-1500
Blue	460-475	300-500

**Recommended Operating Ranges** *(unless otherwise specified, TA=-20 ~ +70 °C, VDD=4.5 ~ 5.5V, VSS=0V)*

Parameter	Symbol	Min.	Typ.	Max	Unit	Test conditions
The chip supply voltage	$V_{DD}$	-	5.0	5.3	V	-
R/G/B port pressure	$V_{DS,MAX}$	-	-	17	V	-
The maximum LED output current	$I_{max}$	-	-	20	mA	-
The clock high level width	TCLKH	-	-	>30	ns	-
The clock low level width	TCLKL	-	-	>30	ns	-
Data set up time	TSETUP	-	-	>10	ns	-
The frequency of PWM	$F_{PWM}$	-	1.2	-	KHZ	-
Static power consumption	$I_{DD}$	-	1	-	mA	-

## Feature Descriptions

### (1) Series data structure

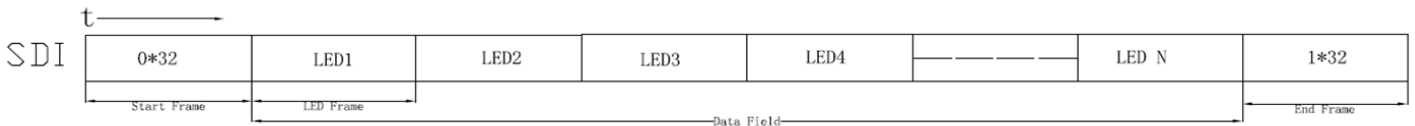

#### Start Frame 32 Bits

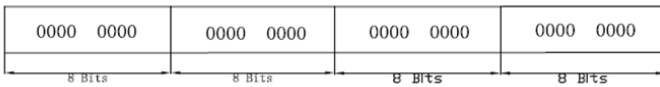

#### LED Frame 32 Bits

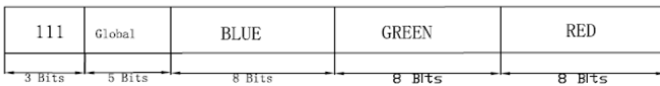

#### End Frame 32 Bits

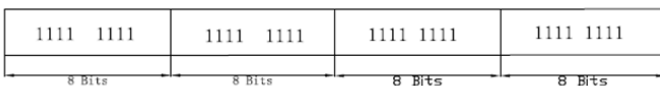

### (2) 256 level gray level

Data	Duty Cycle
<b>MSB.....LSB</b>	
<b>0000 0000</b>	<b>0/256</b>
<b>0000 0001</b>	<b>1/256</b>
<b>0000 0010</b>	<b>2/256</b>
—	—
—	—
—	—
—	—
—	—
<b>11111101</b>	<b>253/256</b>
<b>1111 1110</b>	<b>254/256</b>
<b>1111 1111</b>	<b>255/256</b>

(3) PWM input / output signal relationship

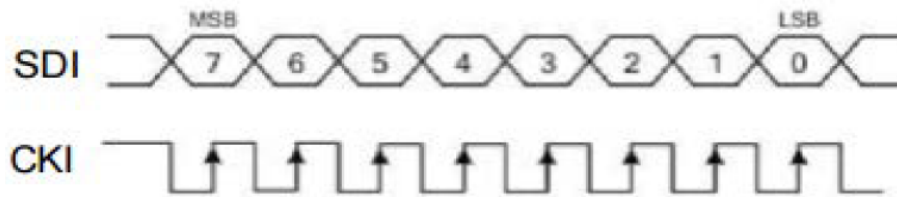

(4) 5-Bit (level 32) brightness adjustment (simultaneous control of OUTR\OUTG\OUTB three ports current):

Data	Driving Current
MSB.....LSB	
00000	0/31
00001	1/31
00010	2/31
-	-
-	-
-	-
-	-
-	-
11101	29/31
11110	30/31
11111	31/31

(5) Refresh Rate

Frame rate =  $1 / ((64 + (32 * \text{points})) * \text{CKI (cycle)})$ , (unit: frames per second)  
 Such as: 1024 points, CKI frequency is 1MHZ, is =30 frames per second frame rate.

## Typical Application Circuit

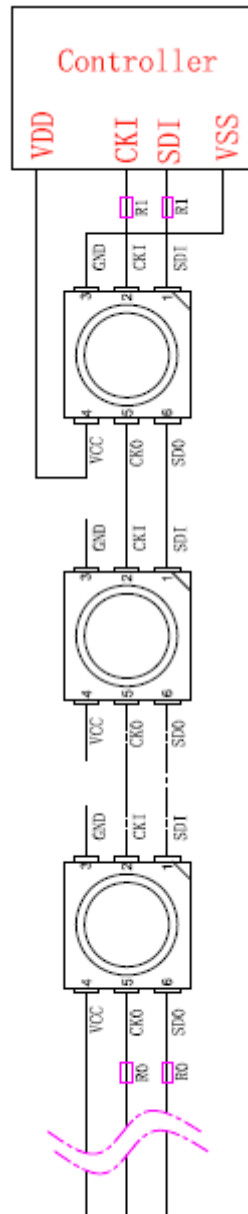

To avoid circuitry surge from damaging the IC, protection resistor is suggested to be added in the circuit design. Capacitors are also suggested to be added to enhance the stability of IC performance.

\*\*When used in LED strip where LED pitch is short, protection resistors are suggested to be placed at signal line input/output and clock line input/output. Suggested resistor values at  $R1 = R0 \sim 500$  ohms.

\*\*When used in module or general applications where pitch is long, protection resistor value needs to be adjusted based on pitch distance and line material.

## LED Performance Graph

Typical Relative Luminous Flux vs. Forward Current

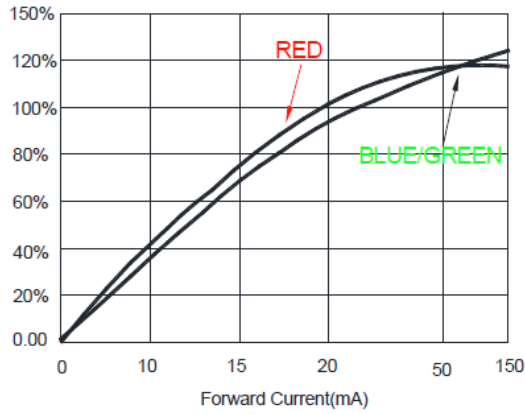

Wavelength Characteristics

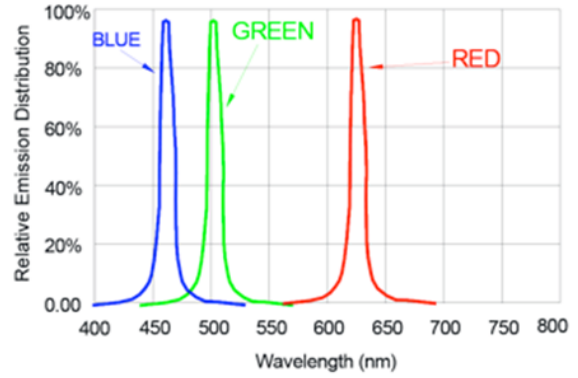

Thermal Pad Temperature vs. Relative Light Output

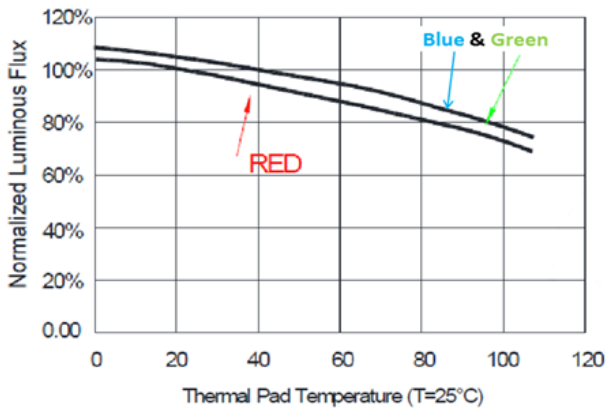

Typical Radiation Pattern 120°

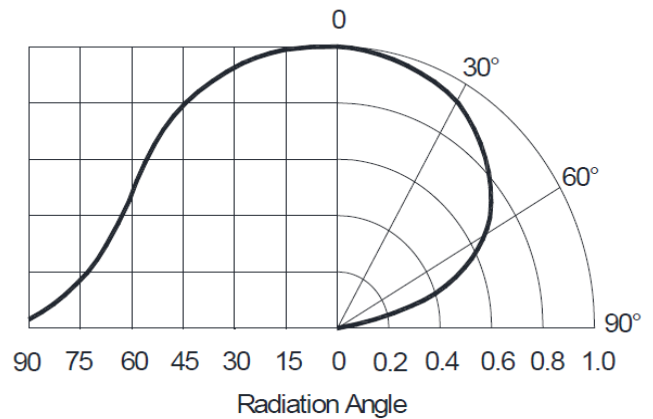



### Ordering Information

Product	Emission Color	IV(mcd)	Orderable Part Number
IN-PC55TBTRGB	R	400-700	IN-PC55TBTRGB
	G	1000-1500	
	B	300-500	

### Label Specifications

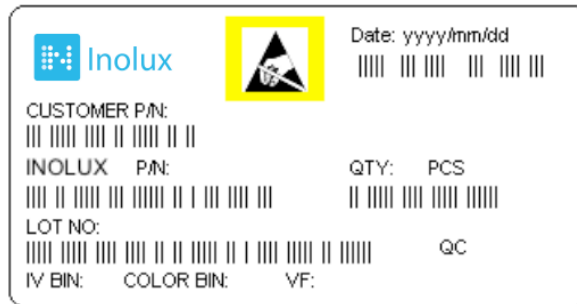

### Inolux P/N:

I	N	PC	-	55	T	B	T		R		G		B	-	X	X	X	X
		Product		Package	Die Qty.	Variation	Orientation	Current	Color	Current	Color	Current	Color		Customized Stamp-off			
Inolux		PI- Single trace IC PC- Clock Function IC		55TB = 5.5 x 5.5 x 1.6 mm, 6 pins			T = Top Mount	Blank= 20mA	R = 624 nm	Blank= 20mA	G = 520 nm	Blank= 20mA	B = 470 nm					

### Lot No.:

Z	2	0	1	7	01	24	001
Internal Tracker	Year (2017, 2018, .....)				Month	Date	Serial

## Precautions

Please read the following notes before using the product:

### 1. Storage

- 1.1 Do not open moisture proof bag before the products are ready to use.
- 1.2 Before opening the package, the LEDs should be kept at 30°C or less and 80%RH or less.
- 1.3 The LEDs should be used within a year.
- 1.4 After opening the package, the remaining LEDs should be kept in a resealed bag.
- 1.5 The LEDs require mandatory baking before usage. Baking treatment listed below.
- 1.6 If the moisture adsorbent material has fabled away or the LEDs have exceeded the storage time, baking treatment should be performed using the following conditions.

\*Baking treatment: 60±5°C for 24 hours.

## 2. Soldering Condition

Recommended soldering conditions:

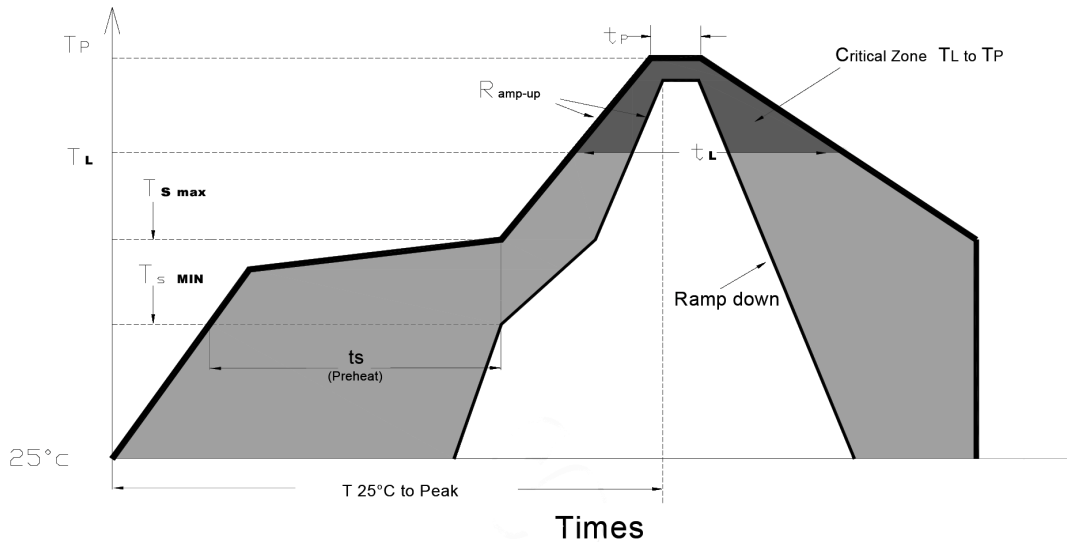

Profile Feature	Lead-Free Solder
Average Ramp-Up Rate ( $T_{s \max}$ to $T_p$ )	3°C/second max.
Preheat: Temperature Min ( $T_{s \min}$ )	150°C
Preheat: Temperature Min ( $T_{s \max}$ )	200°C
Preheat: Time ( $t_{s \min}$ to $t_{s \max}$ )	60-180 seconds
Time Maintained Above: Temperature ( $T_L$ )	217 °C
Time Maintained Above: Time ( $t_L$ )	60-150 seconds
Peak/Classification Temperature ( $T_p$ )	240 °C
Time Within 5°C of Actual Peak Temperature ( $t_p$ )	<10 seconds
Ramp-Down Rate	6°C/second max.
Time 25 °C to Peak Temperature	<6 minutes max.

Note: Excessive soldering temperature and / or time might result in deformation of the LED lens or catastrophic failure of the LED.

### 3. Soldering Iron

Each terminal is to go to the tip of soldering iron temperature less than 260°C for 5 seconds within once in less than the soldering iron capacity 25W. Leave two seconds and more intervals, and do soldering of each terminal. Be careful because the damage of the product is often started at the time of the hand solder.

### 4. Repairing

Repair should not be done after the LEDs have been soldered. When repairing is unavoidable, a double-head soldering iron should be used (as below figure). It should be confirmed beforehand whether the characteristics of the LEDs will or will not be damaged by repairing.

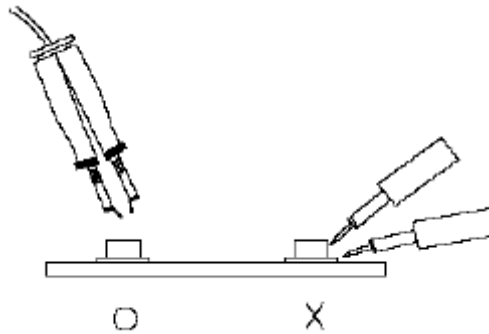

### 5. Caution in ESD

Static Electricity and surge damages the LED. It is recommended to use a wristband or anti-electrostatic glove when handling the LED. All devices, equipment and machinery must be properly grounded.

## Revision History

Changes since last revision	Page	Version No.	Revision Date
Initial Release		1.0	06-30-2018
Revise precautions	10	1.1	07-31-2019

## DISCLAIMER

INOLUX reserves the right to make changes without further notice to any products herein to improve reliability, function or design. INOLUX does not assume any liability arising out of the application or use of any product or circuit described herein; neither does it convey any license under its patent rights, nor the rights of others.

## LIFE SUPPORT POLICY

INOLUX's products are not authorized for use as critical components in life support devices or systems without the express written approval of the President of INOLUX or INOLUX CORPORATION. As used herein:

1. Life support devices or systems are devices or systems which, (a) are intended for surgical implant into the body, or (b) support or sustain life, and (c) whose failure to perform when properly used in accordance with instructions for use provided in the labeling, can be reasonably expected to result in a significant injury of the user.
2. A critical component in any component of a life support device or system whose failure to perform can be reasonably expected to cause the failure of the life support device or system, or to affect its safety or effectiveness.