

Features

- 0.56" (14.20mm) Matrix Height
- Single Digit Display
- Black/Grey Face , White Segment
- IC compatible, Easy assembly
- Dynamic drive connect
- RoHS Compliant, Pb Free

Applications

- Consumer Electronics
- Industrial Equipment

Description

The INND-TS56 series is a 0.56" single digit display. It is a through hole type LED display which can be used in various applications.

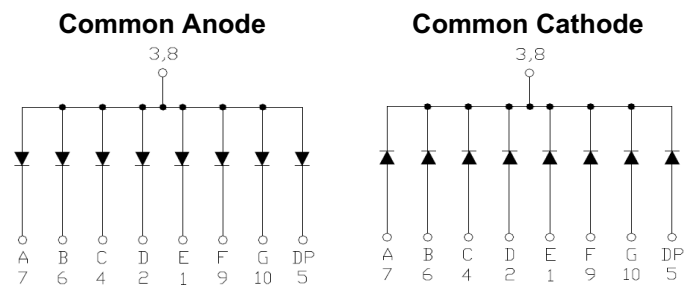


Figure 1. INND-TS56 series Internal Circuit Diagram

Package Dimensions

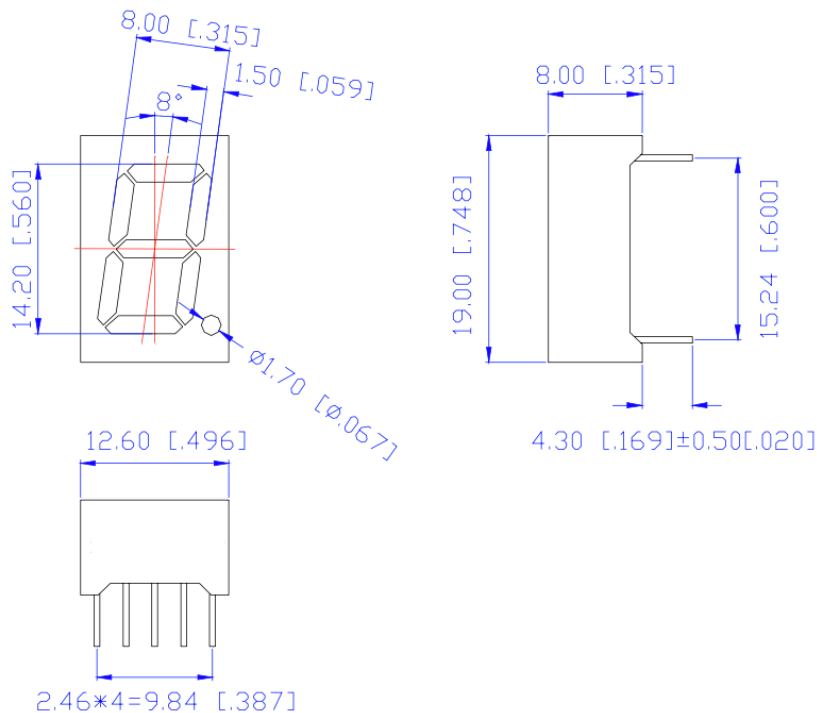


Figure 2. INND-TS56 series Package Dimensions

Notes

1. All pins are $\varnothing 0.51 [0.020] \pm 0.1 [0.004]$
2. Dimension in millimeter [inch], tolerance is $\pm 0.25 [0.010]$ and angle is $\pm 1^\circ$ unless otherwise noted.
3. Bending \leq Length * 1%.

Absolute Maximum Rating at 25°C (Note 1)

Product (Per Segment)	Emission Color	Technology	P _d (mW)	I _F (mA)	I _{FP} * (mA)	V _R (V)	Derate From 25°C (mA/°C)	T _{OP} (°C)	T _{ST} (°C)
INND-TS56YGXX	Yellow Green	AlGaInP	70	25	90	5	0.33	-35°C~+85°C	-35°C~+85°C
INND-TS56YXX	Yellow	AlGaInP	70	25	90	5	0.33	-35°C~+85°C	-35°C~+85°C
INND-TS56AXX	Amber	AlGaInP	70	25	90	5	0.33	-35°C~+85°C	-35°C~+85°C
INND-TS56RXX	Red	AlGaInP	70	25	90	5	0.33	-35°C~+85°C	-35°C~+85°C
INND-TS56DRXX	Deep Red	AlGaInP	70	25	90	5	0.33	-35°C~+85°C	-35°C~+85°C
INND-TS56GXX	Green	InGaN	114	30	100	5	0.4	-35°C~+85°C	-35°C~+85°C
INND-TS56BXX	Blue	InGaN	114	30	100	5	0.4	-35°C~+85°C	-35°C~+85°C
INND-TS56WXX	White	InGaN	114	30	100	5	0.4	-35°C~+85°C	-35°C~+85°C

Notes

1. Condition for IFP is pulse of 1/10 duty and 0.1msec width

Electrical Characteristics $T_A = 25^\circ\text{C}$ (Note 1)

Product (Per Segment)	Emission Color	VF(V)@20mA			λ (nm)@20mA		I*V(mcd)@10mA			IR(μ A)@VR=5V	IV-M @IF =10mA
		min	typ.	max	λ D	λ P	min	typ.	max	max	max
INND-TS56YGXX	Yellow Green	-	2.0	2.8	570	572	-	15	-	100	2:1
INND-TS56YXX	Yellow	-	2.0	2.8	590	592	-	50	-	100	2:1
INND-TS56AXX	Amber	-	2.0	2.8	605	612	-	70	-	100	2:1
INND-TS56RXX	Red	-	2.0	2.8	630	644	-	30	-	100	2:1
INND-TS56DRXX	Deep Red	-	2.0	2.8	645	660	-	25	-	100	2:1
INND-TS56GXX	Green	-	3.2	3.8	525	-	-	218	-	100	2:1
INND-TS56BXX	Blue	-	3.2	3.8	465	-	-	27	-	50	2:1
INND-TS56WXX	White	-	3.2	3.8	X: 0.27 Y: 0.25	-	-	130	-	50	2:1

Notes

1. Performance guaranteed only under conditions listed in above tables.

ESD Precaution

ATTENTION: Electrostatic Discharge (ESD) protection



The symbol above denotes that ESD precaution is needed. ESD protection for GaP and AlGaAs based chips is necessary even though they are relatively safe in the presence of low static-electric discharge. Parts built with AlInGaP, GaN, or/and InGaN based chips are STATIC SENSITIVE devices. ESD precaution must be taken during design and assembly. If manual work or processing is needed, please ensure the device is adequately protected from ESD during the process.

Please be advised that normal static precautions should be taken in the handling and assembly of this device to prevent damage or degradation which may be induced by electrostatic discharge (ESD).

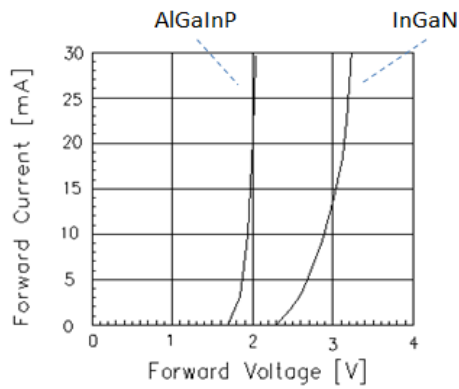
Characteristic Curves for YG, Y, A, R, DR, G


Fig 1. Forward Current vs. Forward Voltage

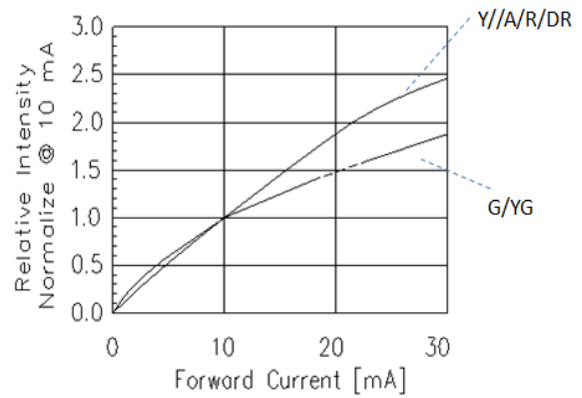


Fig 2. Relative Intensity vs. Forward Current

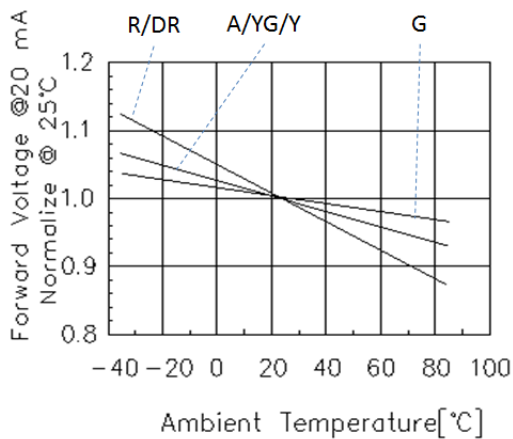


Fig 3. Forward Voltage vs. Temperature

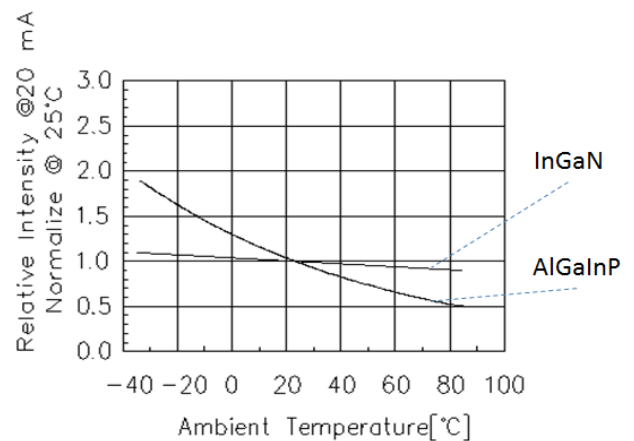


Fig 4. Relative Intensity vs. Temperature

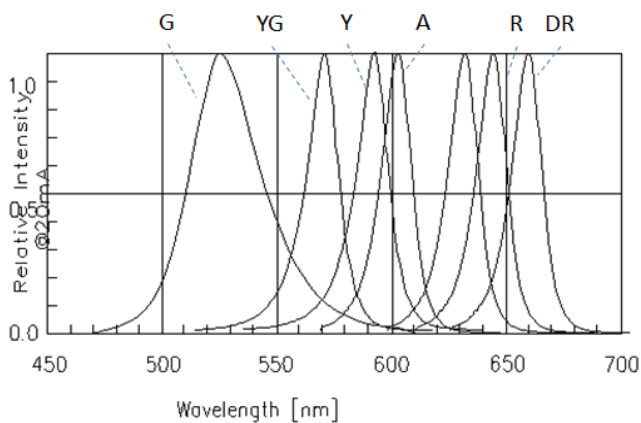


Fig 5. Relative Intensity vs. Wavelength

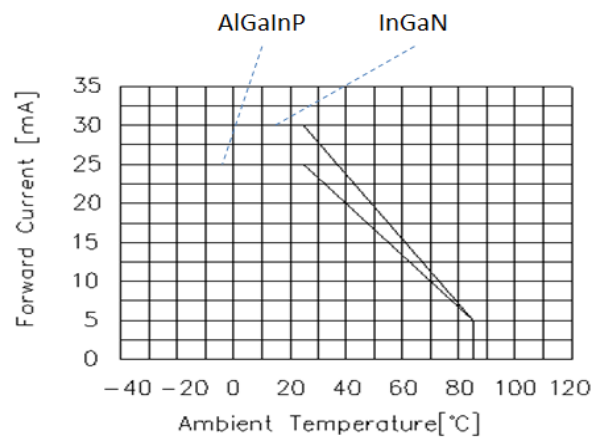


Fig 6. Forward current vs. Temperature

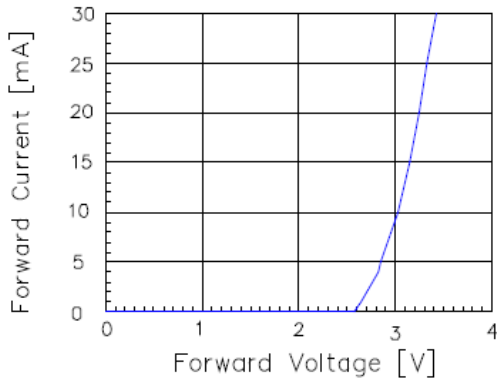
Characteristic Curves for B


Fig 1. Forward Current vs. Forward Voltage

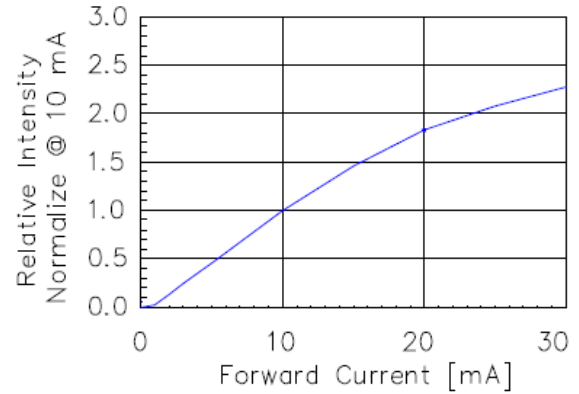


Fig 2. Relative Intensity vs. Forward Current

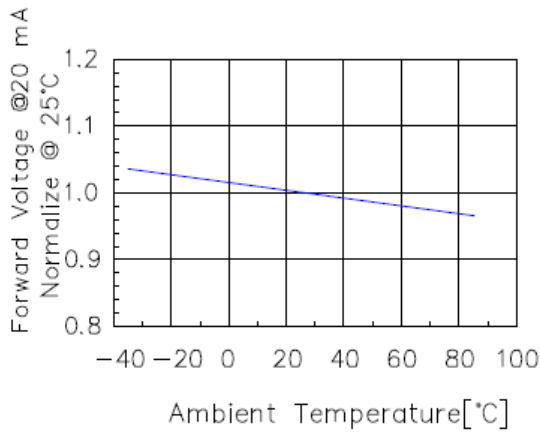


Fig 3. Forward Voltage vs. Temperature

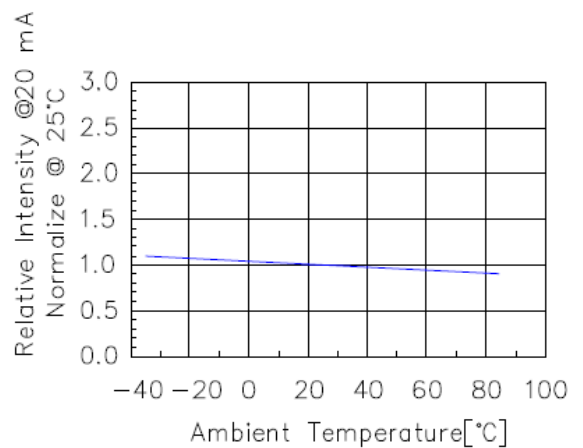


Fig 4. Relative Intensity vs. Temperature

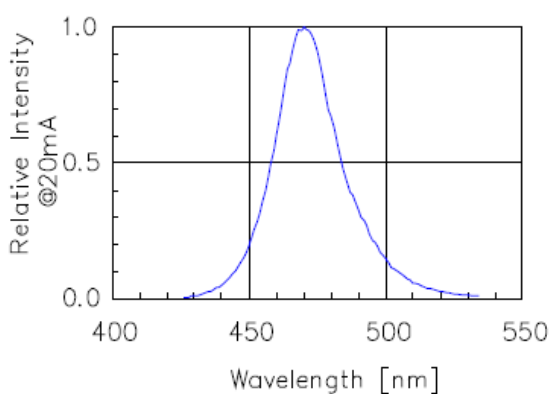


Fig 5. Relative Intensity vs. Wavelength

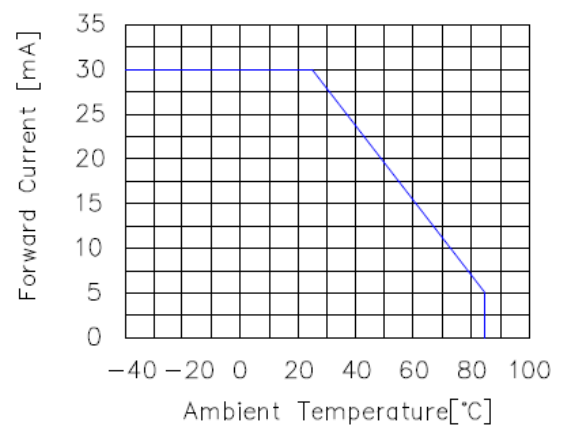


Fig 6. Forward current vs. Temperature

Characteristic Curves for W

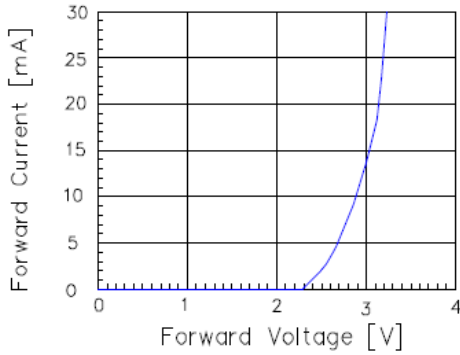


Fig 1. Forward Current vs. Forward Voltage

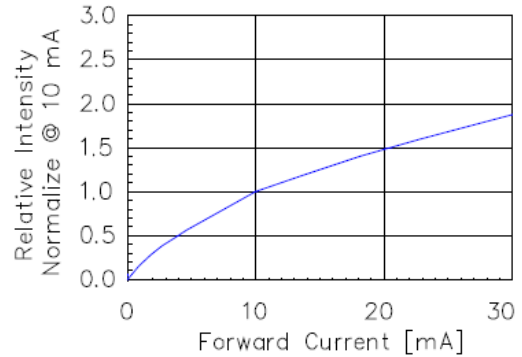


Fig 2. Relative Intensity vs. Forward Current

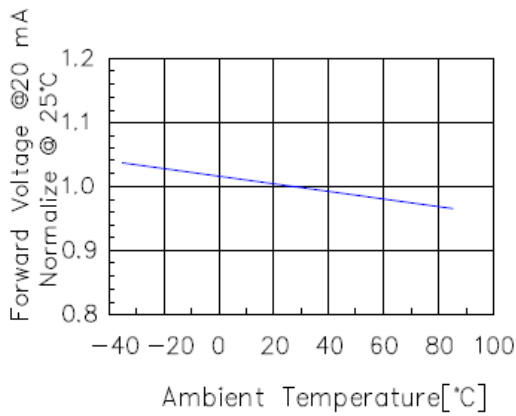


Fig 3. Forward Voltage vs. Temperature

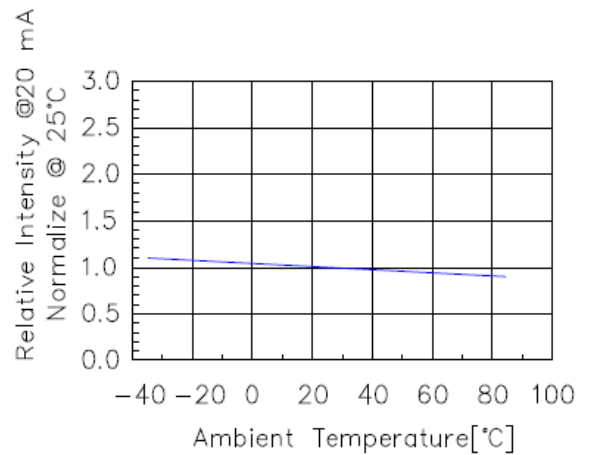


Fig 4. Relative Intensity vs. Temperature

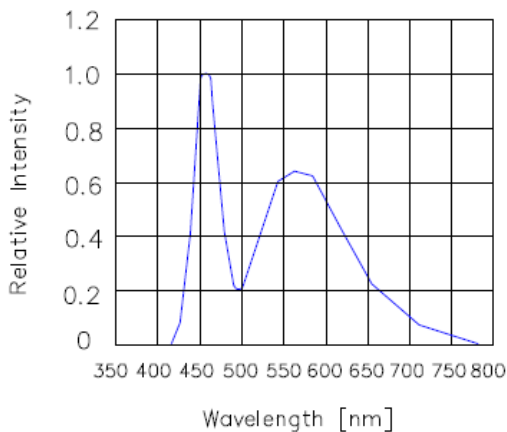


Fig 5. Relative Intensity vs. Wavelength

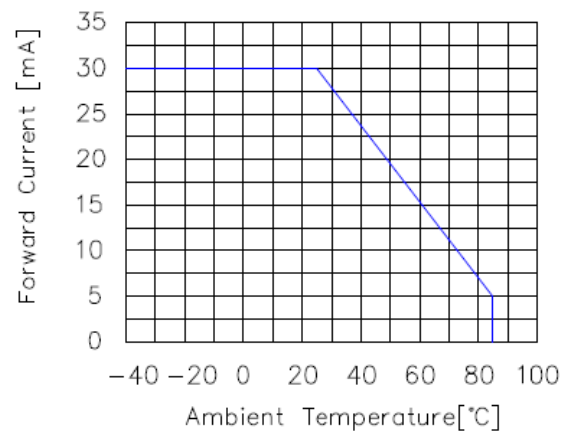
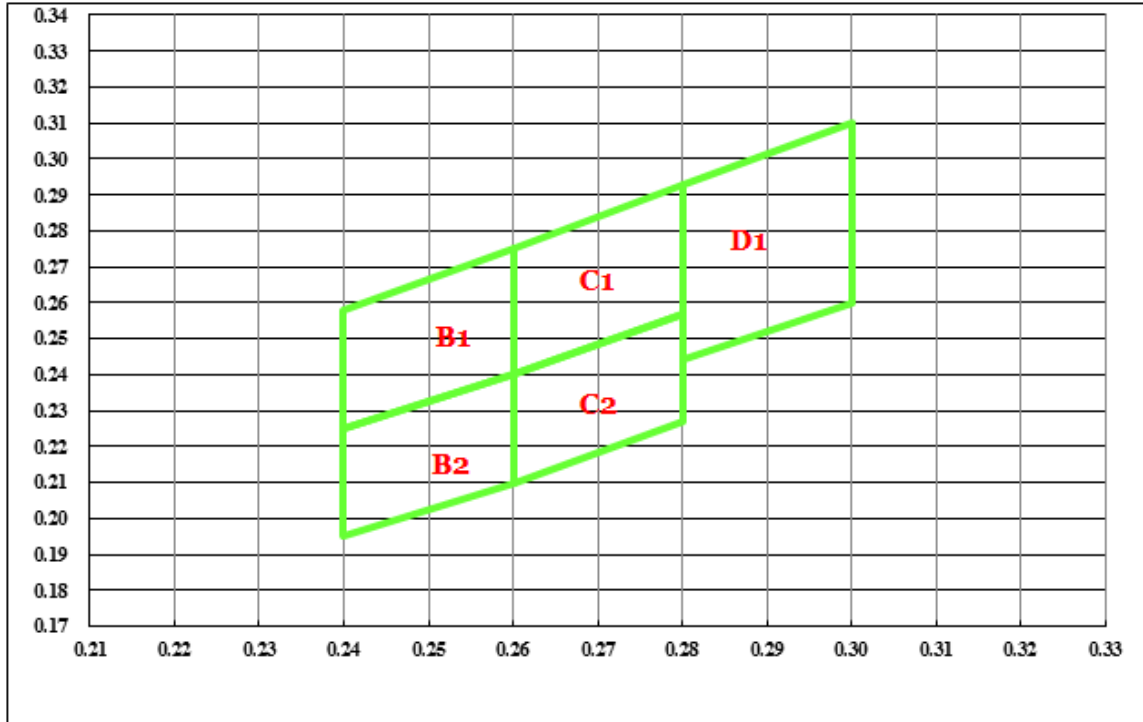


Fig 6. Forward current vs. Temperature

Chromaticity Bin (for White only)


B1				
X	0.240	0.240	0.260	0.260
Y	0.225	0.258	0.275	0.240

B2				
X	0.240	0.240	0.260	0.260
Y	0.195	0.225	0.240	0.210

C1				
X	0.260	0.260	0.280	0.280
Y	0.240	0.275	0.293	0.257

C2				
X	0.260	0.260	0.280	0.280
Y	0.210	0.240	0.257	0.227

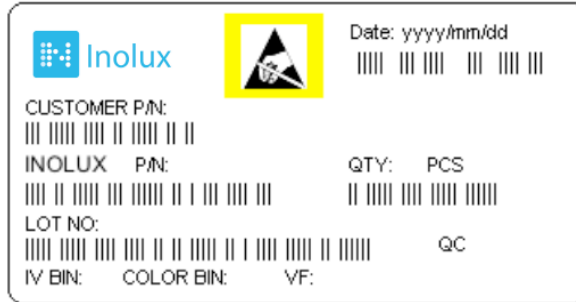
D1				
X	0.280	0.280	0.300	0.300
Y	0.244	0.293	0.310	0.260

Ordering Information

Product	Emission Color	Technology	I*V(mcd) @10mA	VF(V) @20mA	Polarity	Face Color	Orderable Part Number
INND-TS56YGXX	Yellow Green	AlGaInP	15	2.0	Common Anode	Black	INND-TS56YGAB
					Common Cathode	Black	INND-TS56YGCB
					Common Anode	Grey	INND-TS56YGAG
					Common Cathode	Grey	INND-TS56YGCG
INND-TS56YXX	Yellow	AlGaInP	50	2.0	Common Anode	Black	INND-TS56YAB
					Common Cathode	Black	INND-TS56YCB
					Common Anode	Grey	INND-TS56YAG
					Common Cathode	Grey	INND-TS56YCG
INND-TS56AXX	Amber	AlGaInP	70	2.0	Common Anode	Black	INND-TS56AAB
					Common Cathode	Black	INND-TS56ACB
					Common Anode	Grey	INND-TS56AAG
					Common Cathode	Grey	INND-TS56ACG
INND-TS56RXX	Red	AlGaInP	30	2.0	Common Anode	Black	INND-TS56RAB
					Common Cathode	Black	INND-TS56RCB
					Common Anode	Grey	INND-TS56RAG
					Common Cathode	Grey	INND-TS56RCG

Product	Emission Color	Technology	I*V(mcd) @10mA	VF(V) @20mA	Polarity	Face Color	Orderable Part Number
INND-TS56DRXX	Deep Red	AlGaInP	25	2.0	Common Anode	Black	INND-TS56DRAB
					Common Cathode	Black	INND-TS56DRCB
					Common Anode	Grey	INND-TS56DRAG
					Common Cathode	Grey	INND-TS56DRCG
INND-TS56GXX	Green	InGaN	218	3.2	Common Anode	Black	INND-TS56GAB
					Common Cathode	Black	INND-TS56GCB
					Common Anode	Grey	INND-TS56GAG
					Common Cathode	Grey	INND-TS56GCG
INND-TS56BXX	Blue	InGaN	27	3.2	Common Anode	Black	INND-TS56BAB
					Common Cathode	Black	INND-TS56BCB
					Common Anode	Grey	INND-TS56BAG
					Common Cathode	Grey	INND-TS56BCG
INND-TS56WXX	White	InGaN	130	3.2	Common Anode	Black	INND-TS56WAB
					Common Cathode	Black	INND-TS56WCB
					Common Anode	Grey	INND-TS56WAG
					Common Cathode	Grey	INND-TS56WCG

Label Specifications



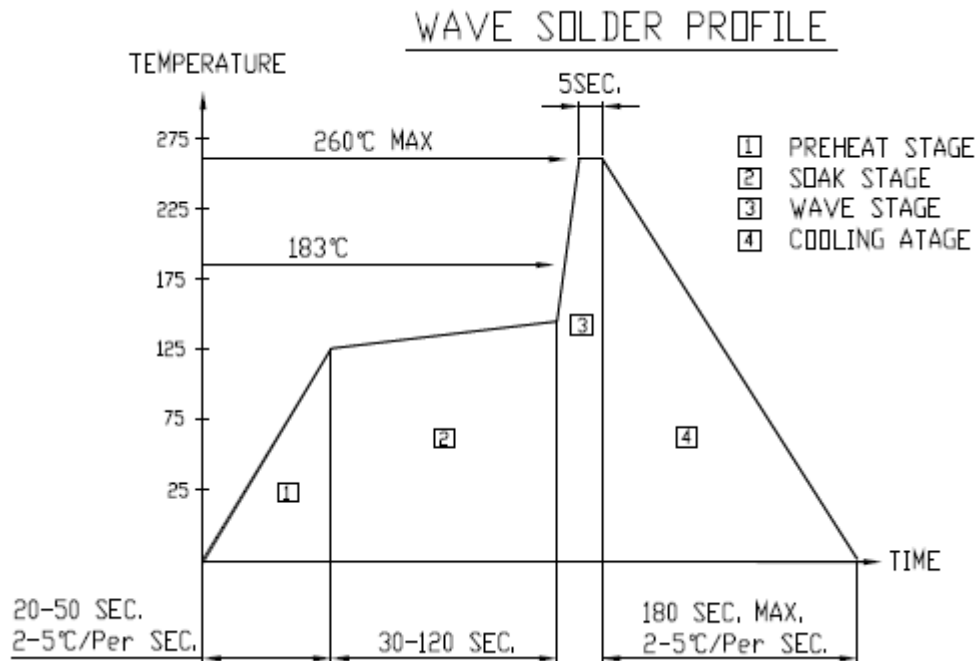
Inolux P/N:

I	N	N	D	-	T	S	5	6	X	X	X	-	X	X	X	X
Inolux		Display Type	Display Type	Dimension	Color	Polarity	Face Color	Customized Stamp-off								
		ND = Numeric Display	T: Through hole S: Single	56 = 0.56" Display Height	YG: 570 nm Y: 590 nm A: 605 nm R: 630 nm DR: 660 nm G: 525 nm B: 465 nm W: X: 0.27 Y: 0.25	A = Common Anode C=Common Cathode	B = Black G = Grey									

Lot No.:

Z	2	0	1	7	01	24	001
Internal Tracker	Year (2017, 2018,)				Month	Date	Serial

Reflow Soldering



Soldering Iron

Basic Spec is ≤ 4 sec. when 260°C (+10°C \rightarrow -1 second). Power dissipation of Iron should be less than 15W. Surface temperature should be under 230°C

Rework

Rework should be completed within 4 second under 245°C

Revision History

Changes since last revision	Page	Version No.	Revision Date
Initial Release		1.0	07-12-2017
Information Update	1	1.1	05-15-2023

DISCLAIMER

INOLUX reserves the right to make changes without further notice to any products herein to improve reliability, function or design. INOLUX does not assume any liability arising out of the application or use of any product or circuit described herein; neither does it convey any license under its patent rights, nor the rights of others.

LIFE SUPPORT POLICY

INOLUX's products are not authorized for use as critical components in life support devices or systems without the express written approval of the President of INOLUX or INOLUX CORPORATION. As used herein:

1. Life support devices or systems are devices or systems which, (a) are intended for surgical implant into the body, or (b) support or sustain life, and (c) whose failure to perform when properly used in accordance with instructions for use provided in the labeling, can be reasonably expected to result in a significant injury of the user.
2. A critical component in any component of a life support device or system whose failure to perform can be reasonably expected to cause the failure of the life support device or system, or to affect its safety or effectiveness.